



**ASKA**<sup>®</sup> **COM**

**ASKA COMMUNICATION CORP**

**CATALOG – 2022**

## CRIMP-ON F-CONNECTORS

**F-56D for RG-6**  
**F-59D for RG-59**  
 With Zinc Die-cast 7/16" Nut



**F-56G**  
**F-56GW with O-ring**  
**F-56SG with O-ring and Silicon**  
 All brass type  
 For RG 6 with 7/16" Nut



## F-SPLICES



**AF-81CBO – Orange**  
**AF-81CBOW - Orange with weather boot**  
 3GHz Brass Splice  
 30dB Return Loss For 5-3000MHz  
 34mm Length- Both Flat ends



**Dish Network Approved**



**AF-81CB - Blue**  
 3GHz Brass Splice  
 30dB Return Loss For 5-3000MHz  
 27mm Length- Both Flat ends

**NW**

Nut & Washer 1/2" Hex  
 100pcs/bag



**AF-81S**

20mm Length  
 Economy type



## RG-11 CONNECTORS and FEED THRU

**AF-11**  
 RG-11 CONNECTOR  
 With Separate ring  
 For RG-11/U coax



**CON-11**  
 RG-11 FEED THROUGH  
 CONNECTOR  
 All zinc die-cast with O-ring



## HARDLINE 1/2" CABLE ADAPTORS

**TRM-1**  
 KS PORT Terminator



**FF-KS**  
 F Female to KS adaptor



# ATTENUATORS AND VOLTAGE BLOCK

**FAM-\***  
 FIXED ATTENUATOR  
 5-2300MHz  
 20dB return loss  
 3,6,8,10,12,16,20dB



**VBC**  
 VOLTAGE BLOCK  
 5-2300MHz  
 20dB return loss



# 75 OHM TERMINATOR

**AF59T1G**  
 Terminator  
 25dB return loss for  
 5-2300MHz



**AF59TPB**  
 Terminator  
 AC/DC BLOCKING  
 20dB return loss for  
 5-2300MHz



# F, RCA, BNC ADAPTOR



**RCA-81**  
 RCA Jack splice



**RCA-F**  
 RCA Jack to F-Male



**FF-R**  
 F Female to RCA Plug



**FTO-56**  
 Twist on RG-6



**FF-RF**  
 F Female to RCA Jack



**BFA**  
 F Female to  
 BNC Male



**BMR**  
 BNC Male to  
 RCA Jack



**BFM**  
 BNC Female to  
 F Male



**AF-90**  
 Right Angle F female  
 to F male



**AF-90P**  
 Right Angle F female  
 to F push on



**AF-71**  
 F male to F male  
 splice



**PF-59**  
 F female to F male  
 push on

## TERMINATING TOOLS



**LTL-4**

Locking terminator  
tool 4" long



**LT-1**

Locking terminator



**LTL-7**

Locking terminator  
tool 7" long

## COMPRESSION TOOLS



**CTL-102**

Economy and compact  
Compression tool  
For most F-type compression  
RG59, RG6 connectors in the  
market



**CTL-104**

Pro compression tool  
Versatile and Fully adjustable  
Works for most F-type compression  
connectors, RG59, RG6, RG6Quad,  
and RG11 compression connectors  
using One flip-over adaptor

## COAXIAL CABLE STRIPPER



**STR-2U**

Universal Coax  
cable stripper  
For RG59, RG6, RG11, CAT5E,  
CAT6, speaker wire etc.



**STR-1**

Coax Cable Stripper  
For RG-59, RG-6

## MODULAR CRIMPING TOOLS



**MCT-3**

RATCHET MODULAR CRIMPING TOOL  
Strip & crimp for 4,6,8 contact modular plugs  
Crimp both handset and line plugs

## OTHER TOOLS



### LEVEL - 3

Template Level  
Level single and dual gang low voltage mounting box  
(vertical & horizontal)



### WR-716

F-connector Torque wrench, 7/16" Hex  
preset torque 30lbs



### AF-701M

Satellite Angle Finder  
Use to check vertical alignment of antenna mast to ensure level plane  
Magnetic base for easy to use  
4" diameter light weight

### DFC

Disposable firm cutter  
Suitable for stretch wrap/shrink wrap/tap



### TIN-2

Insertion & Flaring tool  
for F connector

## CABLE TESTING TOOLS



### CTR-12

Coaxial Cable Tester  
Pocket Toner



### RJ45FF

CTR-8 adaptor  
For testing LAN cable  
(Cat 5E/ Cat 6/6A)



### RJ45FM

CTR-12 adaptor  
For testing LAN cable  
(Cat 5E/ Cat 6/6A)



### CTR-8

Coaxial Cable Mapper  
8 terminator

# HIGH PASS FILTER & SURGE PROTECTOR

## HPF-54

### High Pass Filter

Pass: 54-1000MHz  
 Cut below 50MHz  
 40dB rejection  
 20dB Return Loss



## PT-1

### INLINE SURGE PROTECTOR

Ideal for protection from  
 Lightning for TV,  
 receiver, Computer, etc.



# DIRECTIONAL COUPLERS -1GHz



**DCM1G-()**  
 MINI DIRECTIONAL  
 COUPLER



**DCW1G-()**  
 WALL MOUNT  
 DIRECTIONAL COUPLER

## DCM1G & DCW1G

### Specification:

Tap Value: 6,9,12,16,20, etc.  
 Insertion Loss: 2.5dB Max for 6dB  
 1.5dB for 9 thru 20dB  
 0.5dB for 24 thru 30dB  
 Isolation (Tap –out) 23dB Min  
 Return Loss: 20dB Min

# 1GHz CATV SPLITTER – NO POWER PASSING



**SP-21G**  
 2WAY SPLITTER

Insertion Loss: 4dB  
 Return Loss: 25dB  
 Isolation :25dB



**SP-31G – balance type**  
**SP-31GU- unbalance type**  
 3WAY SPLITTER

Insertion Loss: 6dB/ 4dB+7.5dB  
 Return Loss: 20dB  
 Isolation :23dB



**SP-41G**  
 4WAY SPLITTER

Insertion Loss: 8dB  
 Return Loss: 25dB  
 Isolation :25dB



**SP-81G**  
 8WAY SPLITTER

Insertion Loss: 12dB  
 Return Loss: 20dB  
 Isolation :20dB

## 16 WAY DIGITAL SPLITTER -1GHz

### SP-16G

#### 1GHz 16 Way CATV Splitter

Frequency: 5-1000MHz

Insertion Loss: 14dB Max

Isolation: 25dB Min

Return Loss: 16dB Min

No Power Passing



## 5-2500MHz SATELLITE SPLITTERS



### 2WAY SPLITTER

SP2G-2  
SP2G-2DC  
SP2G-2DS

Insertion Loss: 6dB

Return Loss: 12dB

Isolation :20dB (port to port)



### 3WAY SPLITTER

SP2G-3  
SP2G-3DC  
SP2G-3DS

Insertion Loss: 11dB

Return Loss: 12dB

Isolation :20dB (port to port)



### 4WAY SPLITTER

SP2G-4  
SP2G-4DC  
SP2G-4DS

Insertion Loss: 12dB

Return Loss: 12dB

Isolation :20dB (port to port)

**Note:** SP2G-( ) all ports power passive

SP2G-( )DC one port power passive

SP2G-( )DS all ports diode steered

## SATELLITE DIPLEXER



### SCS-2A

**Dish Network Approved model for Dish Pro receiver Installation**

Specification:

Band width:(ANT) 5-806MHz (SAT) 950-2200MHz

Insertion Loss:(ANT) -2dB Max, (SAT)- 1.5dB Max

Stop band Attenuation: 35dB Min

DC current capability: (SAT port only)-2Amp 28VDC

Return Loss: 12dB Min on both SAT and ANT ports

## INLINE AMPLIFIER

### LA-9520 INLINE Amplifier

Specification:

Frequency Range:950-2400MHz

Gain:20dB

Power requirement: 5-18VDC

Can be used with XM radio

Power passive to connect directly between LNB and satellite receiver or radio output



# DISTRIBUTION AMPLIFIER & FLAT ANTENNA



**AM-1UV**  
UHF/VHF/FM HOME AMPLIFIER  
10dB GAIN



**AM-125**  
25dB GAIN U/V/FM AMPLIFIER  
With FM trap



**AM-125G**  
25dB GAIN U/V/FM AMPLIFIER  
With Gain control & FM trap

**Top-Rated TV Antenna**  
One side black and opposite white

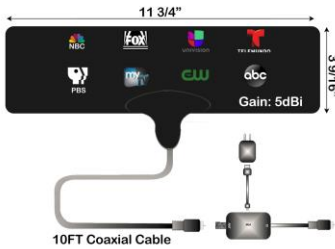

**WSI-B3**  
Flat antenna w/o amplifier  
**WSI-B3-A**  
Flat antenna with USB amplifier

**Top-Rated TV Antenna**  
One side black and opposite white

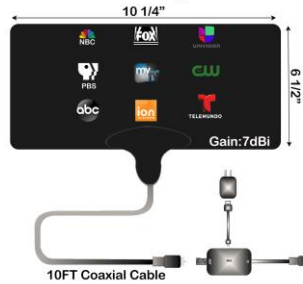

**WSI-B4**  
Flat antenna w/o amplifier  
**WSI-B4-A**  
Flat antenna with USB amplifier

**Top-Rated TV Antenna**  
One side black and opposite white



**WSI-B5**  
Flat antenna w/o amplifier  
**WSI-B5-A**  
Flat antenna with USB amplifier

# DIGITAL RF MODULATOR

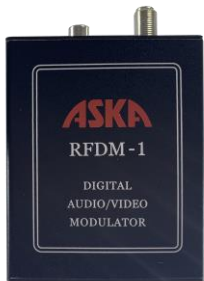

## RFDM-1 DIGITAL UHF MODULATOR

Specification:

Modulates a video and left/right Audio signal of VCR,DVD, Satellite receiver, security camera, etc., to a user selected TV channels

Output channels: UHF:14-74 channels CATV Ultra: 65-135ch

Input level video: 1V min p-p for 87% modulation

Output level: -25dBmV



# VHF RF MODULATOR CH 3 or 4 OUTPUT



## RFM-1G VHF RF MODULATOR

Specification:

\*VHF modulator for Audio and Video

\*Allow the additional channels of VCR,DVD, Satellite receiver to VHF CH-3 or CH-4 channels

\*Switch-able channel selection

\*RCA JACK for Audio/Video inputs

\*F female connector for RF output

\*Output – 30dBm





# Grounding Block

## GB-1

Grounding Block  
With mounting screws



## GB-2D

Dual Grounding Block  
With mounting screws



**Dish Network Approved**

## GB-1UL

Grounding Block  
Return Loss >25dB in 3GHz



## GB-2UL

Grounding Block  
Return Loss >25dB in 3GHz



# UL Listed Grounding Parts



## AGC-1UL

Water Pipe Clamp  
Fits 1/2" – 1-3/8"  
All zinc die-cast



## AGC-2UL

Meter Pan Corner  
Bonding clamp  
Gold zinc plated



## AGC-3UL

Pole Grounding  
Lug wire diameter  
#2 - #14 aluminum



## AGC-4UL

Bonding clamp for  
Meter box front  
All stainless steel



## AGC-1C (UL)

Water Pipe Clamp  
Fits 1/2" – 1-3/8"  
All Copper



## IBEAM-UL

I-BEAM Grounding Clamp  
Teeth on bracket penetrate  
paint and rust for strong  
ground connection



**GS9G-UL - 9"**  
**GS12G-UL - 12"**  
Galvanized  
grounding straps



## SBV-4

For # 4 wire  
Copper to copper  
bonding  
connection

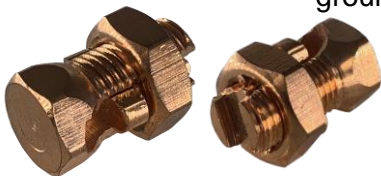

**Dish Network Approved**  
For Copper to copper bonding  
connection

**SB-2U -#2 wire**  
**SB-4U -#4 wire**  
**SB-8U -#8 wire**



## AGC-5UL

Dual Pole Grounding  
Lug wire diameter  
#2 - #14 aluminum

Self-Tapping Ground Screws



## GSW-1

Green Grounding Screw  
Self tapping  
100pcs/bag

# INSTALLATION HARDWARE



## U-CLAMP

U-bolt kit for DBS mounts on outdoor antenna accepts up to 1-3/4" mast set of 2



## AMT-1S

1-5/8" Pipe Adaptor  
Supplied with extra nut on bolts fits for most of DBS pipe



## A-2

Q-SPAN CLAMP  
Galvanized steel bolt  
And aluminum clamp



## ANC-2

1/4" Double expansion  
Anchor lead shield  
100pcs/bag



## NA3/16\*1M 3/16" \*1"

100pcs plastic anchor  
With mushroom head



## PITCH PATCH KIT PPK-1

3 sealant pads with 6 lag bolts

## PPK-2

3 sealant pads

## ANC-KIT

### ANCHOR KIT

100pcs 10X1 anchors  
100pcs Hex head screw  
3/16" masonry drill bit



DB2W-38 – 3/8" wood drill

DB2W-58 – 5/8" wood drill

# CABLE CLIPS

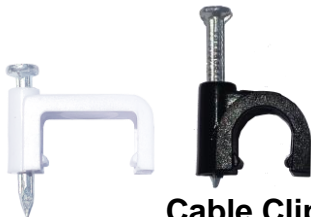

## Cable Clips

- CC-3.5** round wire 3-3.5mm cable
- CC-4F** flat wire 3.5-4mm cable
- CC-6** round wire 5.5-6mm cable
- CC-7** round wire 6.5-7mm cable
- CC-155** flat wire up to 15mm cable

Available in black or white



## Screw-in Cable Clips

Soft & Flexible polyethylene  
Material UV resistance

- CXG-1** for ground lead
- CX-1** suitable for Single RG-6 size
- CX-2** suitable for Dual RG-6 size

Available in black or white

## FEED THRU BUSHING



**FTB-56**

Feed Thru bushing for Single RG-6



**FTBD-56**

Feed Thru bushing for Dual RG-6



**FTB-56X**

Feed Thru bushing for Single RG-6, w/knock-out



**FTBD-56X**

Feed Thru bushing for Dual RG-6, w/knock-out

**Available in black or white**

## WALL PLATES



**ABP-1**

Blanket wall plate Single white or Ivory



**SWP-81**

3GHz F splice wall plate white or Ivory



**SWP-200**

Cable through wall plate white or Ivory



**SWP-10**

Satellite Ribbon cable wall plate white or Ivory



**SWP-20**

Bundled cable wall plate white or Ivory

## WALL MOUNT BRACKETS / LOW VOLTAGE



**WMB-10**  
single gang mounting Box



**WMB-20**  
dual gang mounting Box



**WMB-1**  
Single wall mounting bracket



**WMB-2**  
Dual wall mounting bracket

## KEYSTONE WALL PLATES



**KWP-1**  
1 port wall plate



**KWP-2**  
2 port wall plate

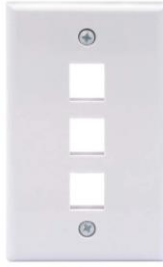

**KWP-3**  
3 port wall plate



**KWP-4**  
4 port wall plate



**KWP-6**  
6 port wall plate

## KEYSTONE SNAP ON INSERTS



**KI-BLK**  
Blank insert



**KI-F1**  
1GHz splice



**KI-F2**  
3GHz splice



**KI-RCA**  
RCA female coupler

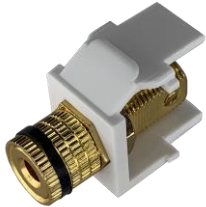

**KI-BP**  
Binding post



**KI-RCAF**  
RCA Jack to F female



**KI-RJ11**  
RJ11 6P4C

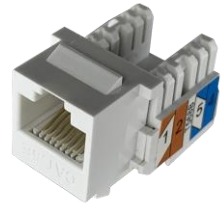

**KI-RJ45**  
CAT 5e keystone

## INSTALLATION PARTS & ACCESSORIES



**ET-60**  
60Ft. Electrical Tap  
3/4"x60Ft. UL listed

**RTV-3**  
SILICON RUBBER  
SEALANT CLEAR  
3 FL. Oz.



**WS-1** - 1/2" long  
**WS-14** - 1/4" long  
**WS-38** - 3/8" long  
Weather seals U/V resistant



**Self-Sealing Tape**  
**SEAL-120** 1.5" X10Ft.  
**SEAL-334** 3-3/4"X10Ft.



**BOX-1**  
Polyethylene water resistant  
Utility box  
8.75" D x 6.25" W x 2.75" H

**Cable Tie- black**  
Tensile strength: 50lb  
**CT-4** - 4"  
**CT-6** - 6"  
**CT-8** - 8"  
**CT-11** - 11"  
**CT-15** - 15"



# TELEPHONE ACCESSORIES



**TMP-4F**  
4 conductor line  
Plug RJ11



**TUY-2**  
2 wire IDC yellow  
Conductor splices  
AWG 22-26wire



**TUR-3**  
3 wire IDC red  
Connector splices  
AWG 22-26 wire



**TMC-3**  
Modular inline coupler  
4 conductor  
White or Ivory



**DSL-1**  
**ADSL Filter**  
Prevent ADSL signal from disturbing  
phone or fax machine, reduce noise  
and enhances signal quality



**TMA-1**  
Modular surface jack  
4 conductor  
White or Ivory



**TMA-2**  
dual surface jack  
4 conductor  
White or Ivory



**TDA-2**  
Modular T adaptor  
4 conductor  
White or Ivory



**Telephone line cords**  
**TLC-7 - 7Ft. grey**  
**TLC-25 - 25Ft. Ivory**



**TCT-2**  
**Phone line tester**  
Can test polarity, and other phone  
Line conditions. Work with 4 or 6  
position modular jacks

# NETWORK ACCESSORIES



**TMP-8F**  
8 conductor line Plug RJ45



**TMP-8FT**  
8 conductor line Plug RJ45  
(cable through)



**TMA-451**  
8C RJ45 surface jack  
Screw on



**TMA-45D**  
8C RJ45 dual surface jack  
Keystone block type



**TMA-452**  
8C RJ45 surface jack  
Keystone bloc type

**TMP-8FS**  
8 conductor line Plug RJ45  
(with copper cover shield)



**Cat 5e network patch cable**  
**NWC-6G - 6Ft. Grey (28AWG/7/0.12MM CCA)**  
**NWC-7G - 7Ft. Grey (26AWG/7/0.16MM CCA)**



**NWC-3R - 3Ft. Red (24AWG/7\*0.19 Copper)**  
**NWC-10R - 10Ft. Red (24AWG/7\*0.19 Copper)**  
**NWC-25R - 25Ft. Red (24AWG/7\*0.19 Copper)**  
**NWC-25Y - 25Ft. Yellow (24AWG/7\*0.19 Copper)**  
**NWC-25G - 25Ft. Green (24AWG/7\*0.19 Copper)**



**TMC-45**  
8 C RJ45 coupler



**TMC-45S**  
8 C RJ45 coupler  
With shield



# AUDIO / VIDEO CABLE



**CF-MM**  
RCA Jack to 2 RCA plug  
Y-adaptor



**Audio Fiber Optic Cable**  
Toslink to Toslink Plug  
**CTLK-3 - -3Ft.**  
**CTLK-6 - 6Ft.**  
**CTLK-10 - 10Ft.**



**CSVH-12B**  
SVHS-SVHS plug  
Gold Plate 12Ft.



**CRR-6G - 6Ft.**  
**CRR-12G - 12Ft.**  
Stereo Audio  
Hook-up cable  
2RCA plug and 2RCA right Plug



**CRR-12B**  
Stereo Audio  
Hook-up cable 12FT  
2RCA plug on both ends



**Stereo Audio/Video Cable**  
Hook-up cable 3RCA  
**CSD-6B - 6Ft.**  
**CSD-12B -12Ft.**

# HDMI CABLE

Premium Quality



**HDMI Cable-1.4 version**  
**CHD14-3 - 3Ft.**  
**CHD14-6 - 6Ft.**  
**CHD14-12 - 12Ft.**  
**CHD14-25 - 25Ft.**  
**CHD14-50 - 50Ft.**

**HDMI Cable-2.0 version**  
**CHD20-6G - 6Ft.**  
**CHD20-6HG - 6Ft.**



# ASKA<sup>®</sup> COM

ASKA COMMUNICATION CORP  
SPEAKER / ALARM / CAT5e / CAT6 AND COAX  
CABLES



# SPEAKER WIRE – RED / BLACK

## SP2/16F(RB)-BC

**Gauge:** 2 Cores /16AWG (65/0.16MM)

**Material:** Stranded Oxygen-Free Copper 99.9% (OFC)

**O.D.:** 3.0X6.0MM Red/Black PVC

**Length:** 250ft

## SP2/14F(RB)-BC

**Gauge:** 2 Cores /14AWG (105/0.16MM)

**Material:** Stranded Oxygen-Free Copper 99.9% (OFC)

**O.D.:** 3.5X7.0MM Red/Black PVC

**Length:** 250ft

## SP2/16F(RB)-CCA

**Gauge:** 2 Cores /16AWG (65/0.16MM)

**Material:** Stranded Copper Clad Aluminum (CCA 30%)

**O.D.:** 3.0X6.0MM Red/Black PVC

**Length:** 250ft

## SP2/14F(RB)-CCA

**Gauge:** 2 Cores /14AWG (105/0.16MM)

**Material:** Stranded Copper Clad Aluminum (CCA 30%)

**O.D.:** 3.5X7.0MM Red/Black PVC

**Length:** 250ft



Speaker Wire - Red/Black

## Oxygen-Free Copper (OFC) VS Copper Clad Aluminum (CCA)

**OFC(99.9%)**  
Premium Audio Experience



**CCA(30%)**  
Cost Effectiveness

16



# SPEAKER WIRE – TRANSPARENT

## SP2/16F(T)-BC

**Gauge:** 2 Cores /16AWG (65/0.16MM)

**Material:** Stranded Oxygen-Free Copper 99.9% (OFC)

**O.D.:** 3.0X6.0MM Transparent PVC

**Length:** 250ft

## SP2/14F(t)-BC

**Gauge:** 2 Cores /14AWG (105/0.16MM)

**Material:** Stranded Oxygen-Free Copper 99.9% (OFC)

**O.D.:** 3.5X7.0MM Transparent PVC

**Length:** 250ft

## SP2/16F(T)-CCA

**Gauge:** 2 Cores /16AWG (65/0.16MM)

**Material:** Stranded Copper Clad Aluminum (CCA 30%)

**O.D.:** 3.0X6.0MM Transparent PVC

**Length:** 250ft

## SP2/14F(T)-CCA

**Gauge:** 2 Cores /14AWG (105/0.16MM)

**Material:** Stranded Copper Clad Aluminum (CCA 30%)

**O.D.:** 3.5X7.0MM Transparent PVC

**Length:** 250ft

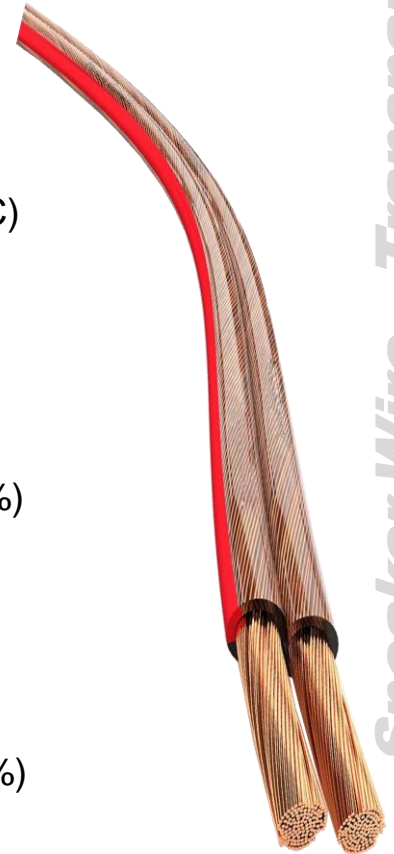

Speaker Wire - Transparent

## Oxygen-Free Copper (OFC) VS Copper Clad Aluminum (CCA)

**OFC(99.9%)**  
Premium Audio Experience



**CCA(30%)**  
Cost Effectiveness

## IN WALL SPEAKER WIRE

### SP2/16B-BC

### SP2/16W-BC

**Gauge:** 2 Cores /16AWG (26/0.254MM)

**Material:** Stranded Oxygen-Free Copper 99.9% (OFC)

**Color:** Black or White

**Length:** 500ft

**Packing:** Reelex Box – Burst test Cardboard 52lbs

UL LISTED CL2/3 RATED

### SP2/14B-BC

### SP2/14W-BC

**Gauge:** 2 Cores /14AWG (41/0.254MM)

**Material:** Stranded Oxygen-Free Copper 99.9% (OFC)

**Color:** Black or White

**Length:** 500ft

**Packing:** Reelex Box – Burst test Cardboard 52lbs

UL LISTED CL2/3 RATED



# IN WALL SPEAKER WIRE

## SP4/16B-BC

## SP4/16W-BC

**Gauge:** 4 Cores /16AWG (26/0.254MM)

**Material:** Stranded Oxygen-Free Copper 99.9% (OFC)

**Color:** Black or White

**Length:** 500ft

**Packing:** Reelex Box

UL LISTED CL2/3 RATED



**Packing**  
wooden spool  
(with carton)

## SP4/14B-BC

## SP4/14W-BC

**Gauge:** 4 Cores /14AWG (41/0.254MM)

**Material:** Stranded Oxygen-Free  
Copper 99.9% (OFC)

**Color:** Black or White Length: 500ft

**Packing:** Wooden Spool in Carton

UL LISTED CL2/3 RATED

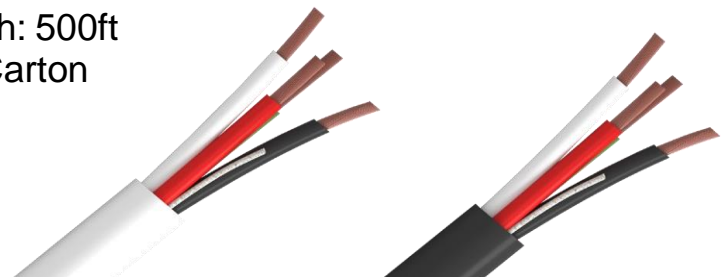

## DIRECT BURIAL SPEAKER WIRE

### SP2/14DB-BC

**Gauge:**

2 Cores /14AWG (41/0.254MM)

**Material:**

Stranded Oxygen-Free Copper 99.9% (OFC)

**Color:** Black or White

**Length:** 500ft

**Packing:** Reelex Box PE Jacket

**Waterproof:**

Gel and clear PET foil inside of PE Jacket.



### SP4/14DB-BC

**Gauge:**

4 Cores /14AWG (41/0.254MM)

**Material:**

Stranded Oxygen-Free Copper  
99.9% (OFC)

**Color:** Black

**Length:** 500ft

**Packing:** Reelex Box

PE Jacket

**Waterproof:**

Gel and clear PET foil inside of PE Jacket.



Direct Burial Speaker Wire - OFC

## IN WALL SPEAKER WIRE CCA

### SP2/16B-CCA

### SP2/16W-CCA

**Gauge:** 2 Cores /16AWG (26/0.254MM)

**Material:** Stranded Copper Clad Aluminum 30% (CCA)

**Color:** Black or White

**Length:** 500ft

**Packing:** Industry Box – Burst test Cardboard 52lbs

UL CL2/3 RATED PVC

---

### SP2/14B-BC

### SP2/14W-BC

**Gauge:** 2 Cores /14AWG (41/0.254MM)

**Material:** Stranded Copper Clad Aluminum 30% (CCA)

**Color:** Black or White

**Length:** 500ft

**Packing :** Industry Box – Burst test Cardboard 52lbs

UL CL2/3 RATED PVC

---



# IN WALL SPEAKER WIRE CCA

## SP4/16B-CCA

## SP4/16W-CCA

**Gauge:** 4 Cores /16AWG (26/0.254MM)

**Material:** Stranded Copper Clad Aluminum 30% (CCA)

**Color:** Black or White

**Length:** 500ft

**Packing:** Industry Box – Burst test Cardboard 52lbs

UL CL2/3 RATED PVC



**Packing**  
wooden spool  
(with carton)



## SP4/14B-CCA

## SP4/14W-CCA

**Gauge:** 4 Cores /14AWG (41/0.254MM)

**Material:** Stranded Copper Clad Aluminum 30% CCA

**Color:** Black or White Length: 500ft

**Packing:** Wooden Spool in Carton

UL CL2/3 RATED PVC

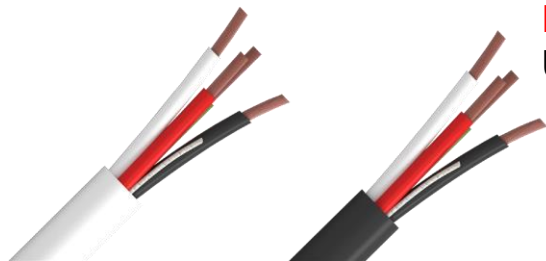

*In Wall Speaker Wire – CCA*

# ALARM / SECURITY CABLE - UL

## ALM2/22-SOLID-BC

**Gauge:** 2 Cores /22AWG (0.64MM)  
**Material:** Solid Oxygen-Free Copper  
99.9% (OFC)  
**Color:** White  
**Length:** 500ft  
**Packing:** Easy Box  
UL LISTED CL2/3 RATED

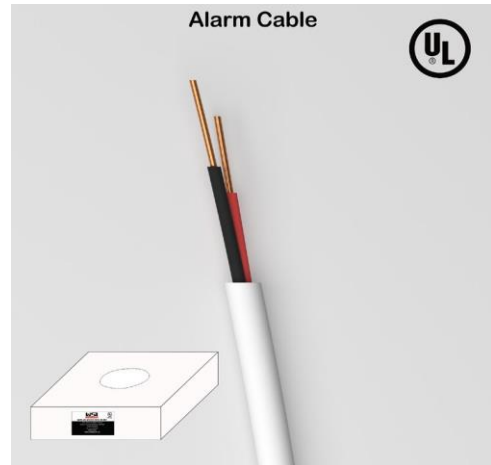

## ALM2/22-STRAND-BC

**Gauge:** 2 Cores /22AWG (7/0.254MM)  
**Material:** Strand  
Oxygen-Free Copper 99.9% (OFC)  
**Color:** White  
**Length:** 500ft  
**Packing:** Easy Box  
UL LISTED CL2/3 RATED



## ALM2/22ASH-STRAND-BC

**Gauge:** 2 Cores /22AWG (7/0.254MM)  
**Material:** Strand  
Oxygen-Free Copper 99.9% (OFC)  
**Shield:** Aluminum Foil + Ground Wire  
**Color:** White  
**Length:** 500ft  
**Packing:** Easy Box  
UL LISTED CL2/3 RATED



Alarm/Security Cable - OFC UL Listed

# ALARM / SECURITY CABLE - UL

## ALM4/22-SOLID-BC

**Gauge:** 4 Cores /22AWG (0.64MM)

**Material:** Solid

Oxygen-Free Copper 99.9% (OFC)

**Color:** White

**Length:** 500ft

**Packing:** EasyBox

UL LISTED CL2/3 RATED

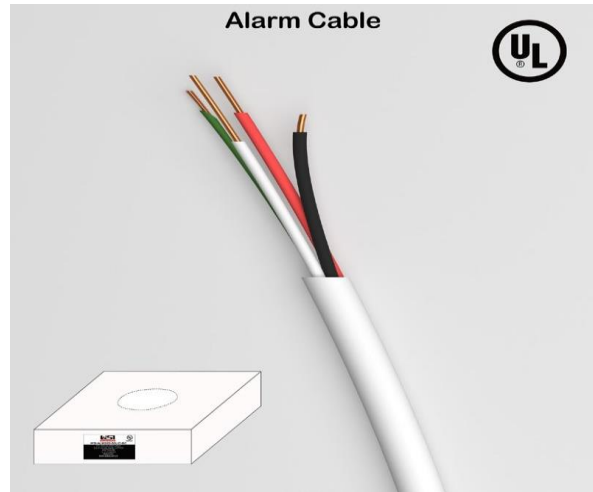

## ALM4/22-STRAND-BC

**Gauge:** 4 Cores /22AWG (7/0.254MM)

**Material:** Strand

Oxygen-Free Copper 99.9% (OFC)

**Color:** White

**Length:** 500ft

**Packing:** EasyBox

UL LISTED CL2/3 RATED

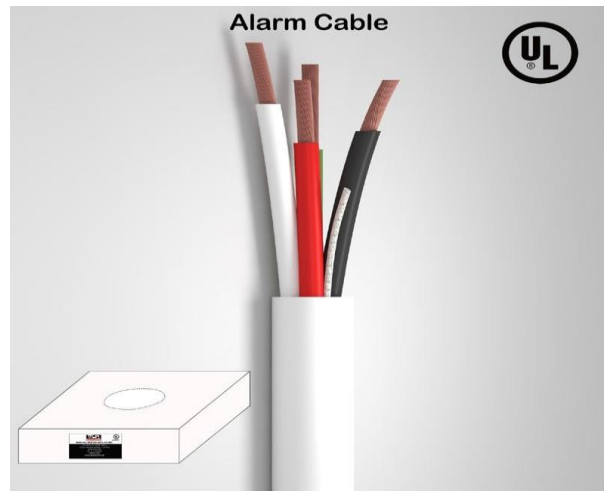

## ALM4/22ASH-STRAND-BC

**Gauge:** 4 Cores /22AWG (7/0.254MM)

**Material:** Strand

Oxygen-Free Copper 99.9% (OFC)

**Shield:** Aluminum Foil + Ground Wire

**Color:** White

**Length:** 500ft

**Packing:** EasyBox

UL LISTED CL2/3 RATED

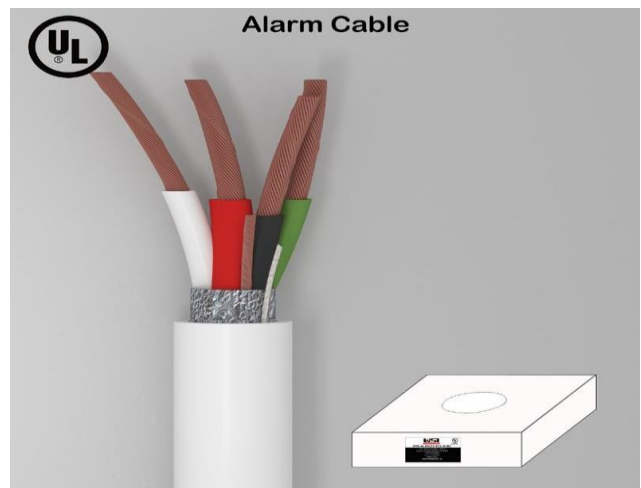

Alarm/Security Cable - OFC UL Listed



# ALARM / SECURITY CABLE - CCA

## ALM2/22-SOLID-CCA

**Gauge:** 2 Cores /22AWG (0.64MM)

**Material:** Solid

Copper Clad Aluminum 30% CCA

**Color:** White

**Length:** 500ft

**Packing:** EasyBox

UL CL2/3 RATED PVC

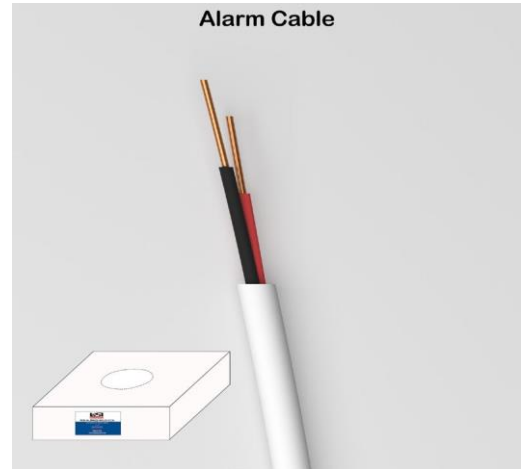

## ALM2/22-STRAND-CCA

**Gauge:** 2 Cores /22AWG (7/0.254MM)

**Material:** Strand

Copper Clad Aluminum 30% CCA

**Color:** White

**Length:** 500ft

**Packing:** EasyBox

UL CL2/3 RATED PVC

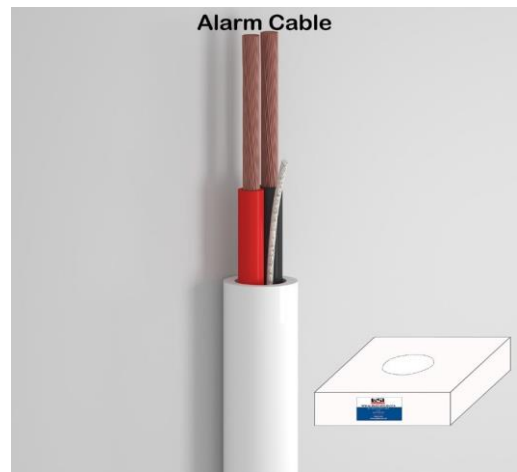

## ALM2/22ASH-STRAND-CCA

**Gauge:** 2 Cores /22AWG (7/0.254MM)

**Material:** Strand

Copper Clad Aluminum 30% CCA

**Shield:** Aluminum Foil + Ground Wire

**Color:** White

**Length:** 500ft

**Packing:** EasyBox

UL CL2/3 RATED PVC

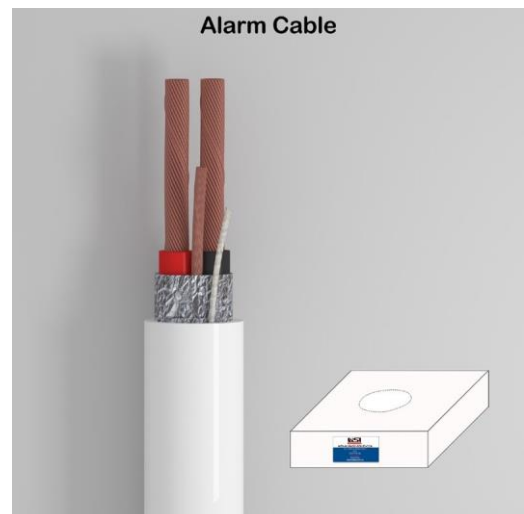

CCA  
Alarm/Security Cable -

# ALARM / SECURITY CABLE - CCA

## ALM4/22-SOLID-CCA

**Gauge:** 4 Cores /22AWG (0.64MM)

**Material:** Solid

Copper Clad Aluminum 30% CCA

**Color:** White

**Length:** 500ft

**Packing:** EasyBox

UL CL2/3 RATED PVC

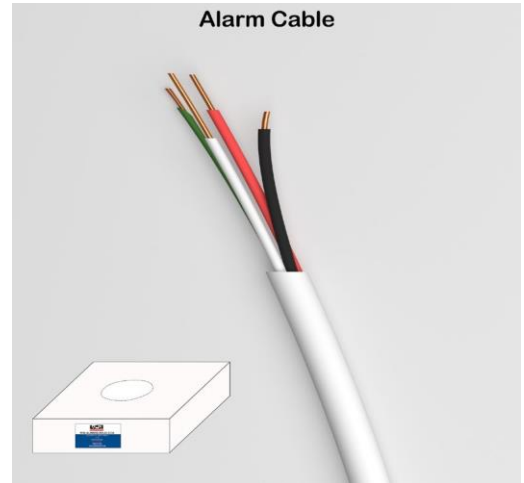

## ALM4/22-STRAND-CCA

**Gauge:** 4 Cores /22AWG (7/0.254MM)

**Material:** Strand

Copper Clad Aluminum 30% CCA

**Color:** White

**Length:** 500ft

**Packing:** EasyBox

UL CL2/3 RATED PVC

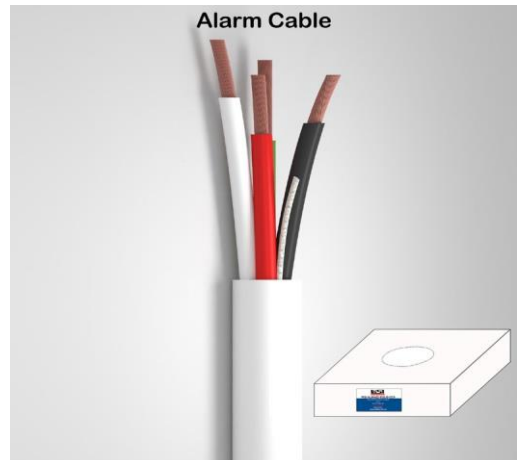

## ALM4/22ASH-STRAND-CCA

**Gauge:** 4 Cores /22AWG (7/0.254MM)

**Material:** Strand

Copper Clad Aluminum 30% CCA

**Shield:** Aluminum Foil + Ground Wire

**Color:** White

**Length:** 500ft

**Packing:** EasyBox

UL CL2/3 RATED PVC

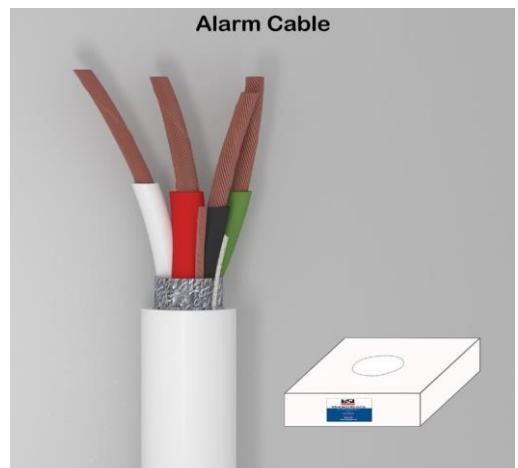

Alarm/Security Cable - CCA

# UTP CAT5e CABLE

## UTP CAT 5E

**Gauge:** 24AWG

**Material:** Solid Oxygen-Free Copper 99.9% (OFC)

**Color:** White

**Length:** 1000ft

**Packing:** Reelex Box – Burst test Cardboard 52lbs

UL LISTED CM RATED

## UTP CAT 5E (OUTDOOR)

**Gauge:** 24AWG

**Material:** Solid Oxygen-Free Copper 99.9% (OFC)

**Color:** Black PE Jacket

**Length:** 1000ft

**Packing:** wooden spool



REELEX

### UTP CAT 5E

UL Listed CM Rated PVC Jacket

24AWG Solid Bare Copper (OFC)

LAN CABLE - UTP CAT 5E UL Listed

# UTP CAT6 CABLE

## UTP CAT 6

**Gauge:** 23AWG

**Material:** Solid Oxygen-Free Copper 99.9% (OFC)

**Color:** White or Blue

**Length:** 1000ft or 250ft

**Packing:** Reelex Box – Burst test Cardboard 52lbs

UL LISTED CM RATED



REELEX

## UTP CAT 6

UL Listed CM Rated PVC Jacket

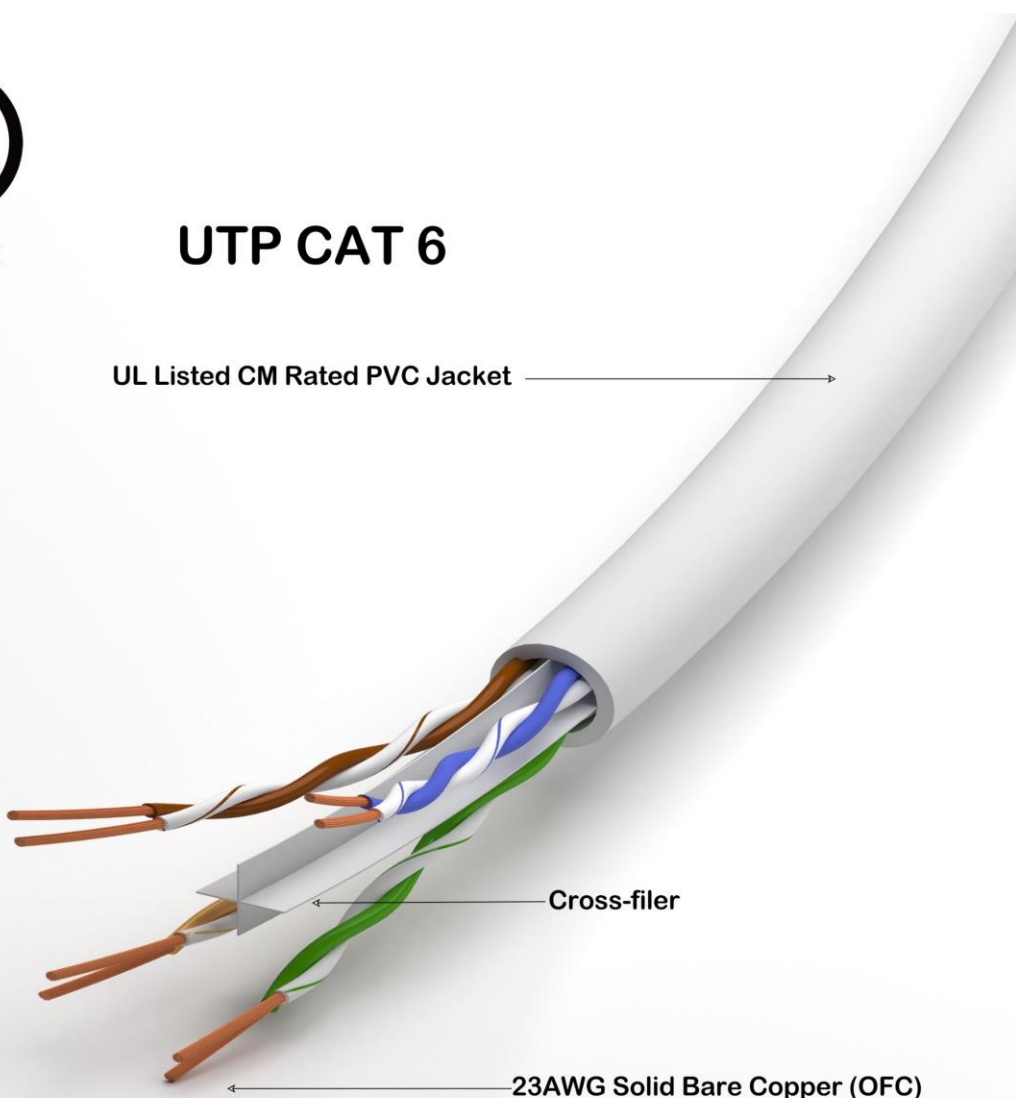

Cross-filer

23AWG Solid Bare Copper (OFC)

LAN CABLE - UTP CAT 6 UL Listed

# UTP CAT6A CABLE

## UTP CAT 6

**Gauge:** 23AWG

**Material:** Solid Oxygen-Free Copper 99.9% (OFC)

**Color:** White or Blue

**Length:** 1000ft

**Packing:** Wooden Spool

UL LISTED CM RATED

## UTP CAT 6A



Bandwidth: Tested up to 750MHz  
Suitable for 10Gigabit Ethernet  
Transmit Length: >100M  
Support PoE, PoE+ and PoE++  
Compliance with ANSI/TIA 568.2-D

UL listed CM Rated PVC Jacket

Cross Filer

23AWG Solid Bare Copper (OFC)

LAN CABLE - UTP CAT 6A UL Listed

## UTP CAT5e / CAT6 CABLE - CCA

**UTP CAT 5E CCA-1000**

**UTP CAT5E CCA-500**

**UTP CAT 5E CCA-250**

**Gauge:** 24AWG

**Material:** Solid Copper Clad Aluminum (CCA) Color: White/Blue/Grey

**Length:** 1000ft/500FT/250FT Packing: **PULLBOX**

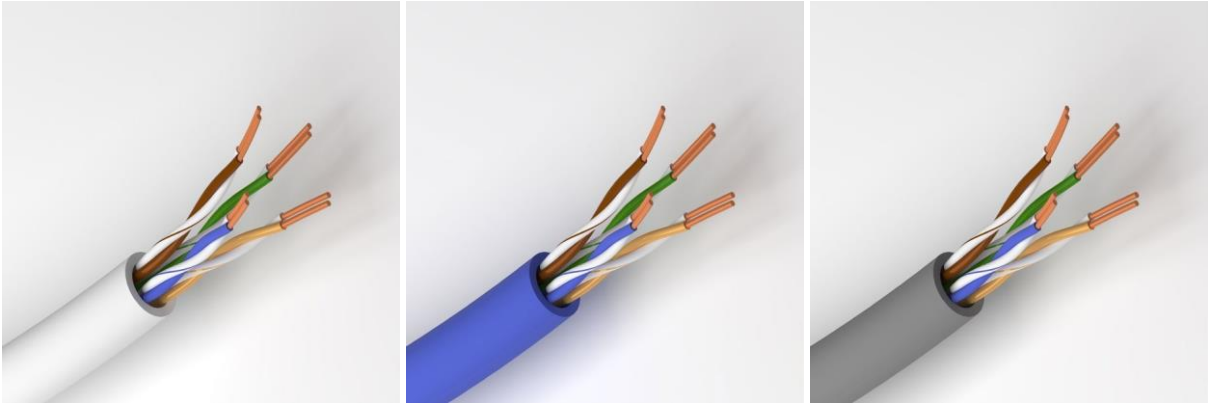

## UTP CAT6 CABLE - CCA

**UTP CAT 6 CCA-1000**

**UTP CAT 6 CCA-250**

**Gauge:** 24AWG

**Material:** Solid Copper Clad Aluminum (CCA)

**Color:** White/Blue/Grey

**Length:** 1000ft/250FT

**Packing:** Pull Box or Wooden Spool in Carton

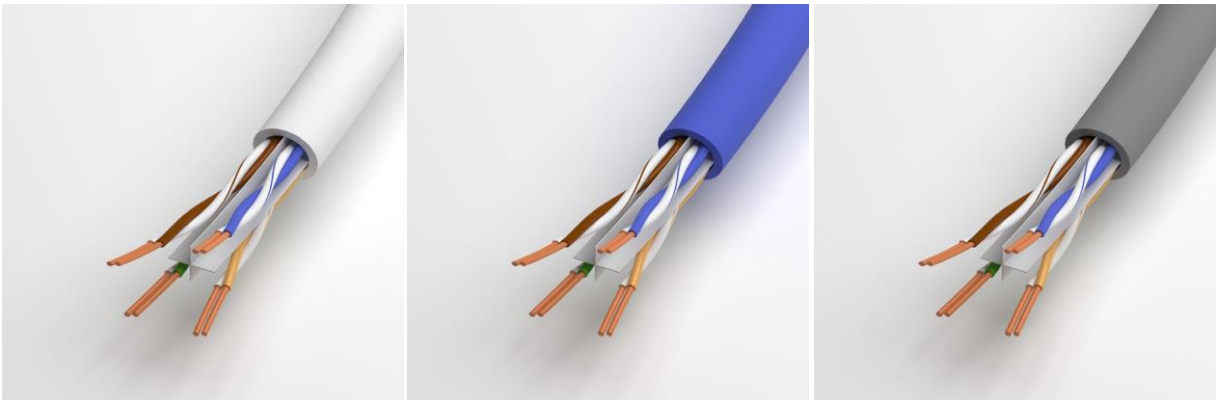

LAN CABLE - UTP CAT 5E/6 CCA

# SIAMESE CABLE

## Siamese Cable



Intertek  
RG-59

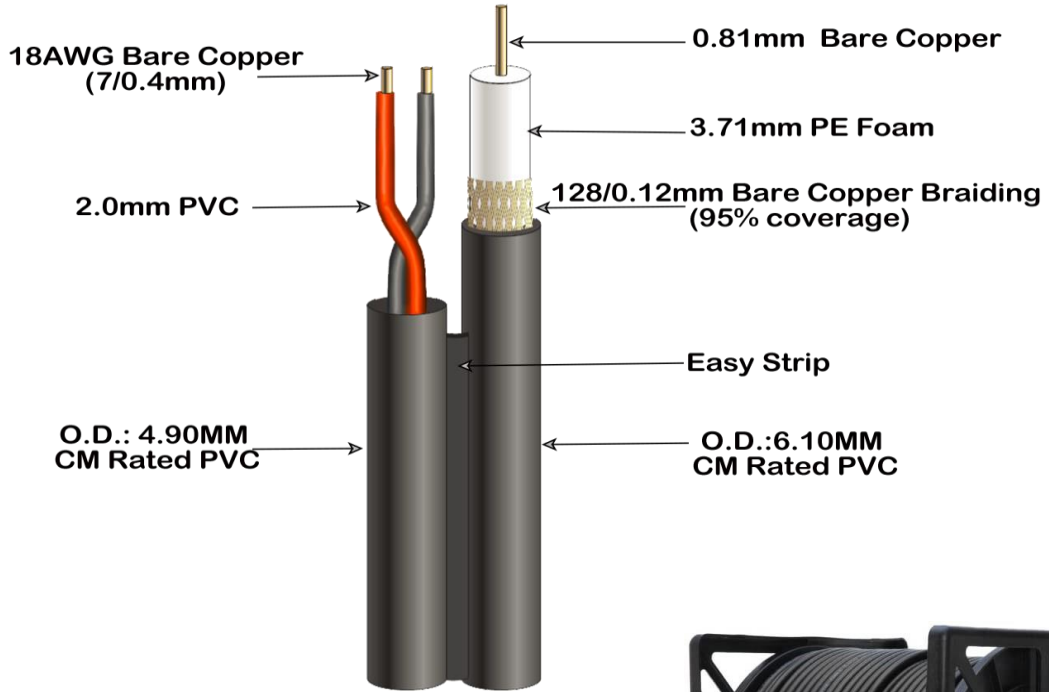

Bare Copper conductor  
Siamese Cable



**Color: black**  
**Length: 500ft**



Security System



Siamese Cable - ETL

## Siamese Cable - ETL (OFC)

# SIAMESE CABLE CCA

## Siamese Cable

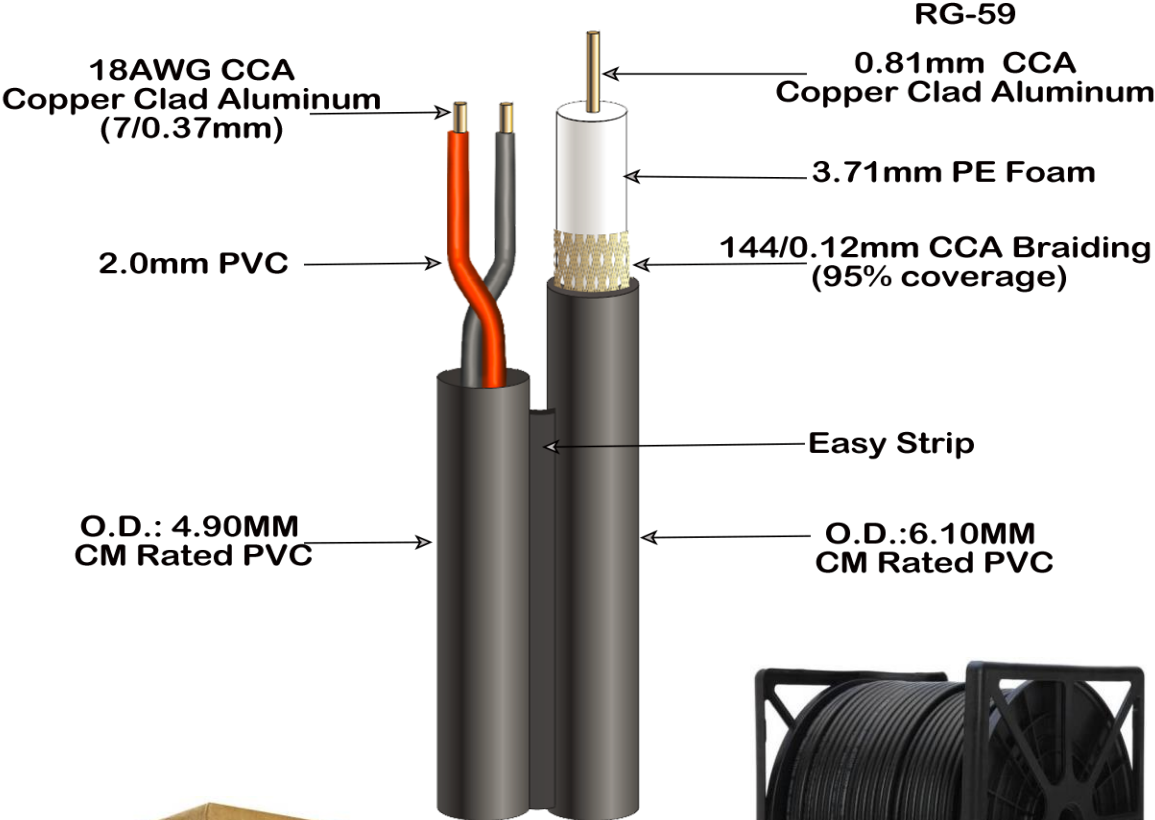

Color: black  
Length: 500ft

## Siamese Cable - CCA

Siamese Cable - CCA



# RG-59 COAX CABLE

## RG-59 Cable

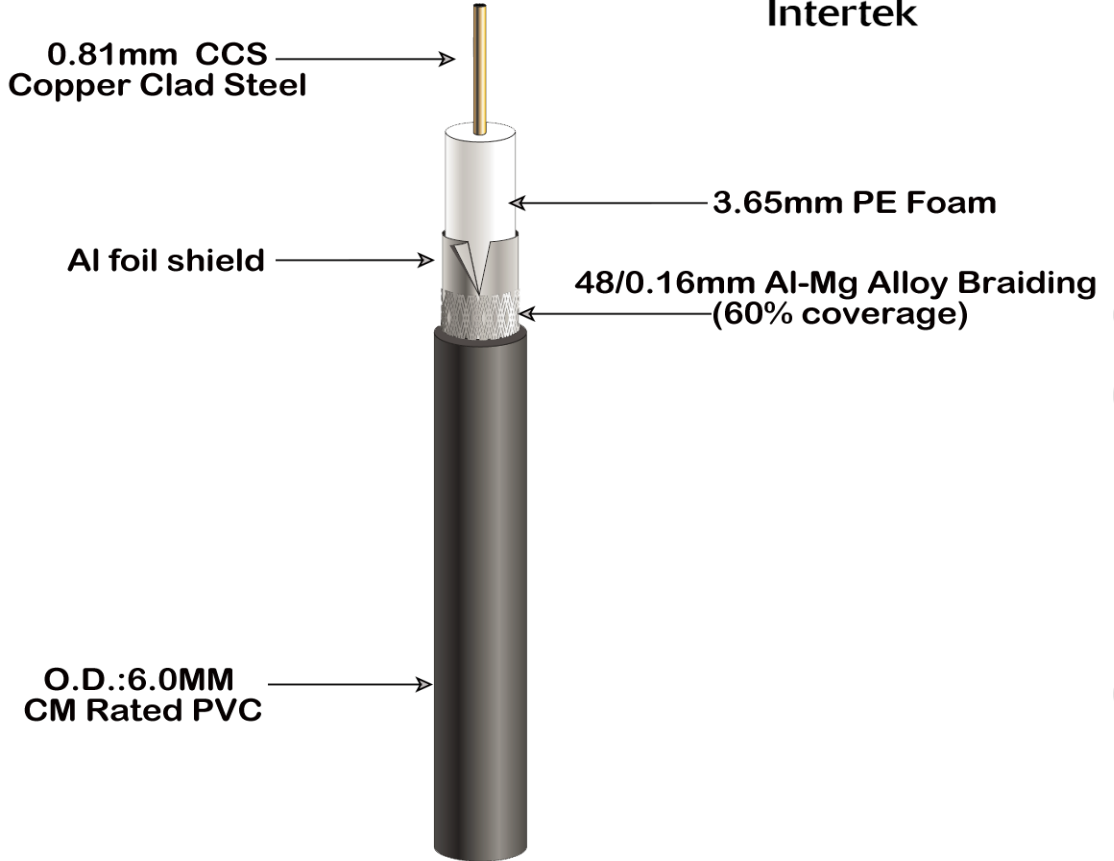

**Color: Black or White**  
**Length: 1000ft**



*Coaxial Cable - RG59 ETL*

# ASKA<sup>®</sup> COM



## IPHONE ACCESSORIES

## LIGHTNING – USB CABLE

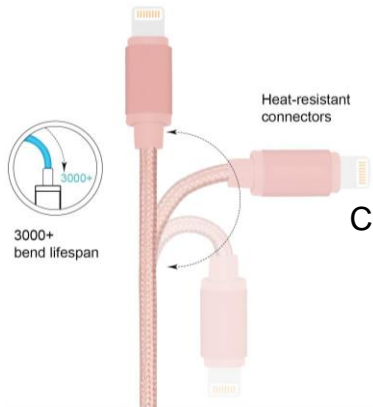

**AWUL-6 - 6Ft.**  
Material: Tinned Copper  
Color: Black, Red, Rose Gold etc.  
Length: 3Ft., 6Ft.,etc.  
Suitable for all iPhone series



## USB C – LIGHTNING CABLE



**AWUCL-6 - 6Ft.**  
Material: Tinned Copper  
Color: Black, Silver, Red, Rose Gold etc.  
Length: 3Ft., 6Ft.,etc.  
Suitable for all iPhone series



Top quality tinned copper conductor (wire) ensures quick charging and strong signal transfer

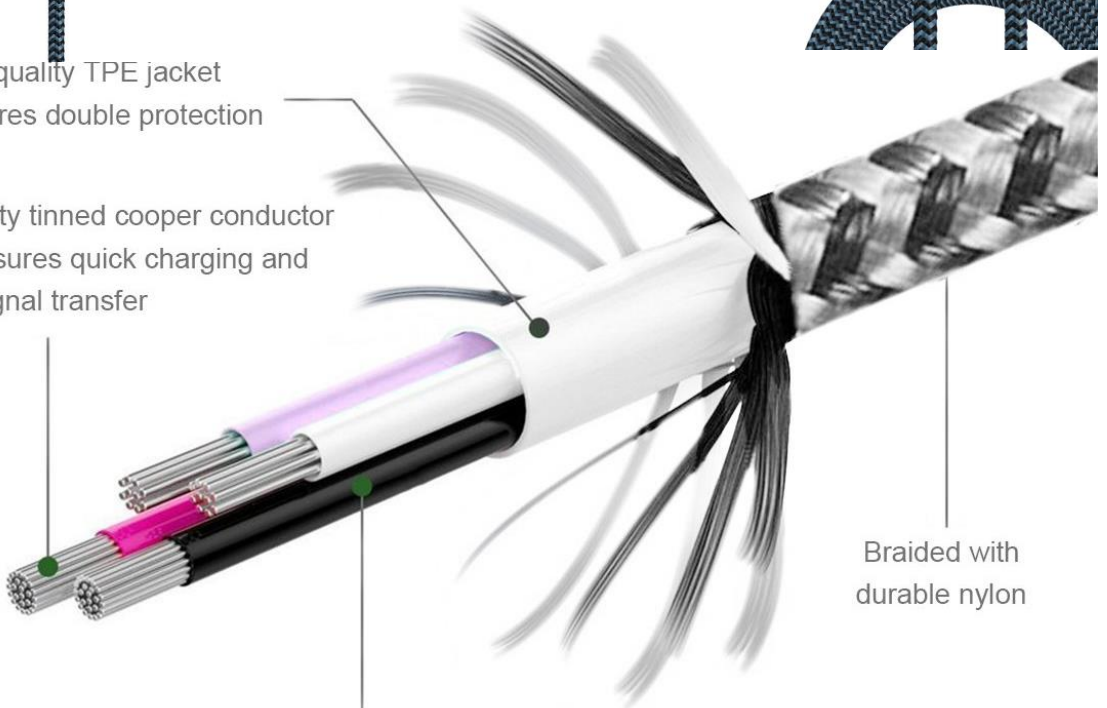

Made for  
iPod iPhone iPad

## DUAL USB CHARGER - FOLDABLE

### AWTCDU- 01

#### Dual USB Traveling Charger Foldable blade design

Input: 100-240V

Output: 5V 2.4A

Automatic device detection

Safe charging

Automatic power cutoff

Color: Black, White, Red, Rose Gold etc.



## USB C + USB CHARGER

### AWTCUCU- 01

#### USB C+ USB Traveling Charger

Input: 100-240V

Output: 5V/3A, 9V/2A, 12V/1.5A

Automatic device detection

Safe charging

Automatic power cutoff

Color: White, Black



## USB C CHARGER

### AWTCUC- 01

#### USB C Traveling Charger

Input: 100-240V

Output: 5V/3A, 9V/2A

Automatic device detection

Safe charging

Automatic power cutoff

Color: White, Black



**Universal Charger: iPhone / iPad or Samsung etc.**

## USB WIRELESS CHARGER

### **AWWC- 01**

#### **Wireless Charger**

Input: 5-9V/2A

Output: 10W

Automatic device detection

Safe charging

Automatic power cutoff

Color: Black with LED lighting



**Note: Charger not included.**

**Please use ASKA charger and keep fast charging**

## USB C WIRELESS CHARGER

### **AWFWC- 01**

#### **USB C Faster Wireless Charger**

Input: 5-12V/2A

Output: 10W-15W

Automatic device detection

Safe charging

Automatic power cutoff

Color: White, Black



**Note: Charger not included.**

**Please use ASKA charger and keep fast charging**

## iPhone 15W WIRELESS MAGNETIC CHARGER

### **AWFWCIP- 01**

#### **USB C iPhone 15W Wireless Charger**

Input: 5-12V/2A

Output: 15W

Automatic device detection

Safe charging

Automatic power cutoff

Color: White, Black



**Note: Charger not included.**

**Please use ASKA charger and keep fast charging**

**Universal Charger: iPhone/ iPad or Samsung etc.**

## USB CHARGING STATION

### AWUCS- 01

#### USB Charging Station

Input: 110-240V 50-60Hz

Total Output: 68W (6 port)

PD 20W :5V/3A,9V/2.22A, 12V/1.67A Max 20W (PD3.0)

QC 3.0: 5V/3A, 9V/2A, 12V/1.5A Max: 18W

USB: 5V/2.4A (smart charge)

Automatic device detection

Safe charging

Automatic power cutoff

Color: White or Black

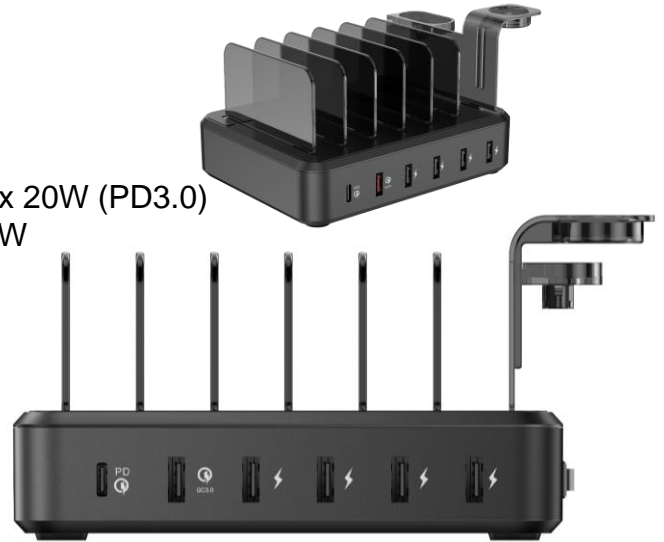

## iPhone & iWatch CHARGING DOCK

### IPW-02

2 in 1

iPhone, iWatch Stand

Material: Aluminum

Color: Silver

Suitable for all iPhone and iWatch  
Charger and magnetic pad not included

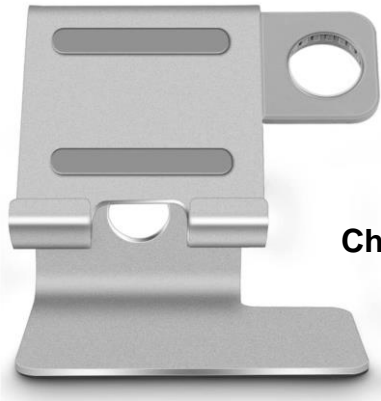

## iWatch STAND

### IPW-01

iWatch Stand

Material: Aluminum

Color: Silver

Suitable for all series of iWatch  
Charger and magnetic pad not included



Made for



iPod



iPhone



iPad

## APPLE PEN AND ACCESSORIES



### AWIPC

#### Apple Pen Cap

Included: 3 pcs different color cap  
Silver/Gold/Rose God

**AWIPH**  
Apple Pen Holder  
Optional color  
White/Black/Orange  
**Note: 1PC holder only**



## iPad CASE SET

### IPS- 01B – black

### IPS- 01MG –Midnight Green

#### 10.2" iPad Case Set

1. Bluetooth keyboard
2. 10.2" iPad case
3. Charging cable for keyboard

### IPSL- 02B – black

### IPSL- 02MG –Midnight Green

#### 10.9" iPad Case Set

1. Bluetooth keyboard **with backlit**
2. 10.9" iPad case
3. Charging cable for keyboard

**Note: Apple Pen not included**



### Smart Power Saving Auto Asleep/wake

Instant wake when opening the folio/instant asleep when closing the folio



Built-in rechargeable lithium-ion battery  
Fast, fluid and soft typing keys



Made for



iPod



iPhone



iPad



# ASKA<sup>®</sup> COM

**ASKA COMMUNICATION CORP.**

2020 NW 129 AVE

SUITE 205

MIAMI, FL. 33182, U.S.A.

[www.askacom.com](http://www.askacom.com)

<https://askacom.us/>

**Phone: 954-708-2387    Email: [sales@askacom.com](mailto:sales@askacom.com)**